

THE PROPERTY OF THE DRAWING IS ESTABLISHED BY LAW. IT IS FORBIDDEN TO PRODUCE OR SHOW IT TO THIRD PART. WITHOUT A WRITTEN AGREEMENT.

Item	Name	Q.ty
1	GWP.6.16	1

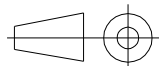
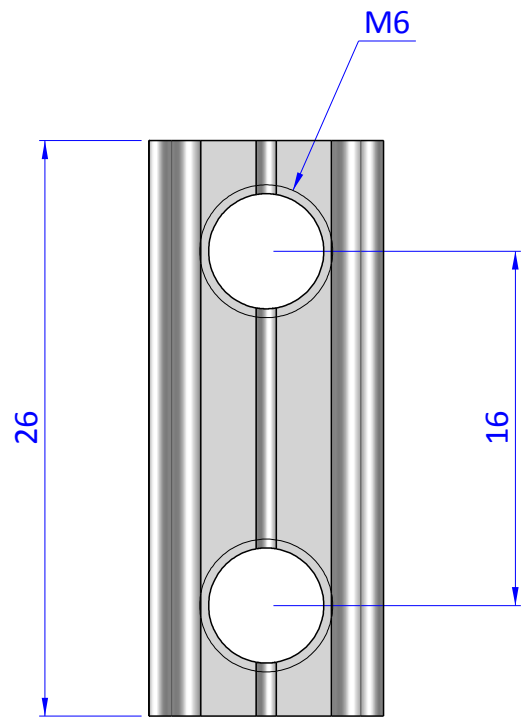
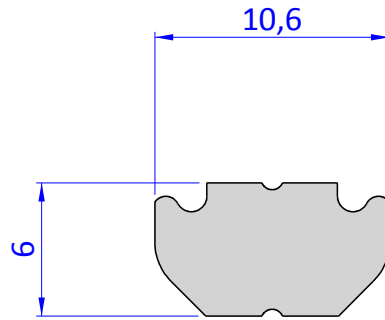
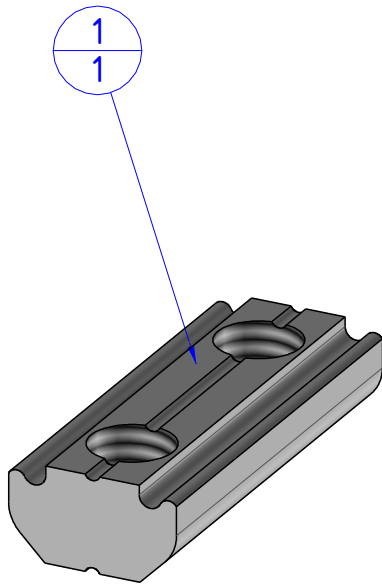

Format A4
UNI 936-76

GENERAL TOLERANCE
UNI - ISO 2768
CLASSE f

DESCRIPTION
CA.GWP.6.16

DESIGNED FROM FPSERVICES	REVIEW A / 4
DATE 15/10/2018	WEIGHT 0,009kg
CODE CA.GWP.6.16	